

Schematics



■ Vers.183+701+502+502+010+502+184



■ Vers.183+701+502+184



■ Vers.183+502+184

Schematics

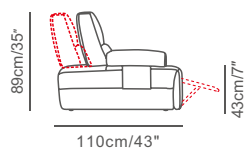

110cm/43"

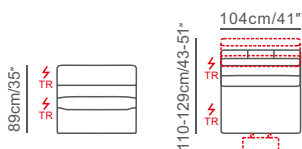

1.5P RL
1800

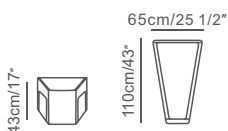

AT-A
701

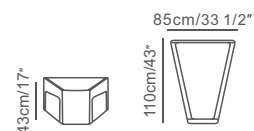

AT-AL
701L

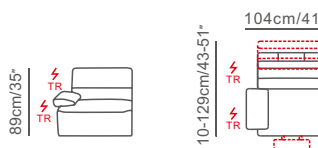

1.5PL RL
183

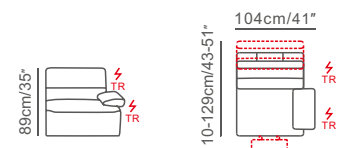

1.5PR RL
184

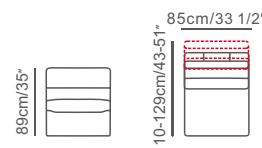

1.5CB
502

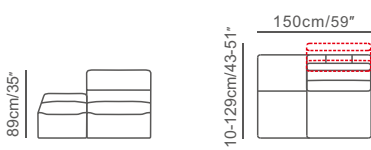

AFL
405

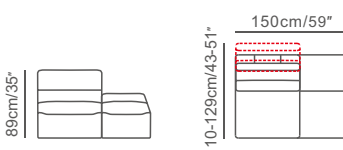

AFR
406

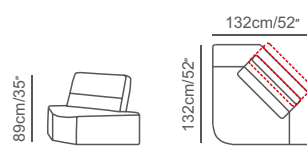

CC
010

Composition Examples

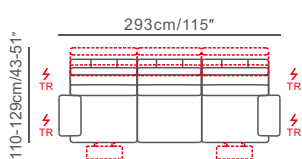

183+502+184

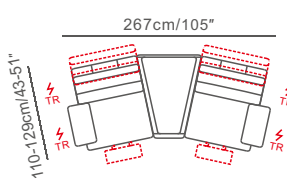

183+701+184

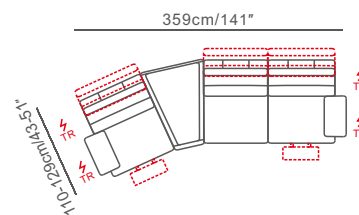

183+701+502+184

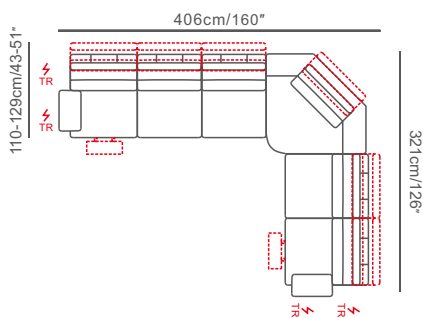

183+502+502+010+502+184

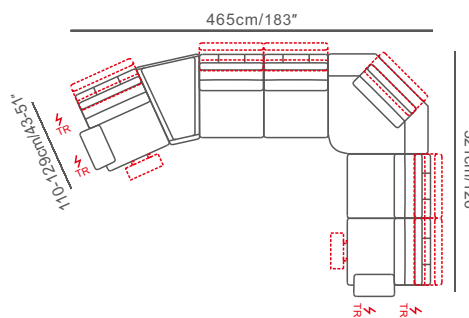

183+701+502+502+010+502+184

*布艺因弹力不一样，单件尺寸+/-3cm

*Different cover material will lead to a +/- 3 cm variation on product size